

DATE	PROJECT	FIRM	FIXTURE TYPE
------	---------	------	--------------

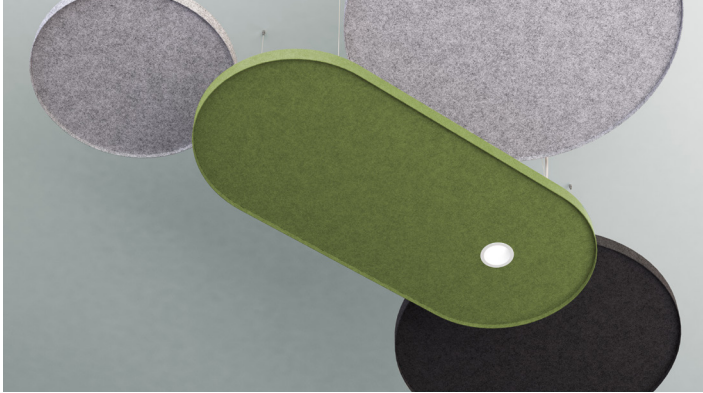

LAYER DISC - LIT

Layer is scalable, flat, and simple. Reinforced with aluminum extrusion, Layer delivers the strength of a grid, the positional flexibility of Unistrut, and the opportunity for customization of a pendant luminaire all in one optimized package. Offered in customizable dimensions and offset luminaire placements, this fixture's forms can be stacked and scattered throughout a space to provide a one-of-a-kind experience for any interior environment. Choose from a number of shapes, sizes, optical & lumen packages, configurations to curate a product tuned to your needs. Our commitment to craft shows up Sabin's signature sewn construction, which enables robust and simple design.

SPECIFICATIONS

SERIES	DIAMETER ¹	CCT/CRI	CIRCUIT	DIRECT OUTPUT	DIRECT OPTIC	CONTROL
LYR-D-L	24" (600MM)	927	SC SINGLE CIRCUIT	D750 750LM	DNS 15° NARROW SPOT DSP 25° SPOT DFL 40° FLOOD DWF 60° WIDE FLOOD DGA ³ +90° GENERAL AMBIENT	10 0-10V TO 1%
	35" (900MM)	930		D1500 1500LM		10B 0-10V TO 0.1%
	47" (1200MM)	935		D2000 2000LM		ECO LUTRON ECOSYSTEM
	CD ²	940		D2500 2500LM		ELV TRIAC/ELV
				D3000 3000LM		DALI DALI
				WD1000 1000LM		DMX DMX
LIGHT SOURCE TRIM COLOR		FELT COLOR			CORD COLOR ⁴	
LWH WHITE LBK BLACK		15BR BEETROOT 15OB OBSIDIAN 15BS BISQUE 15PN PINE 15CN CANARY 15PM PUMICE 15FL FLINT 15QY QUARRY 15GF GULF 15SP SAPPHIRE 15HZ HAZEL 15SD SAND 15JD JADE 15SF SAFFRON 15MY MERCURY 15SA SIENNA 15MS MOSS 15WS WISTERIA			PCBK BLACK PCBL BLUE PCBR BRONZE PCGR GREEN PCRD RED PCGY GRAY PCWH WHITE	
MOUNTING		CANOPY ⁶		FACTORY OPTIONS ⁷		
AC __ 60" AIRCRAFT CABLE + (COLOR CODE) ⁵ WEB __ 60" WEBBING + (COLOR CODE) ⁵ TRD 3/8" THREADED ROD DTS DIRECT TO STRUT DTG DIRECT TO GRID		RWH ROUND WHITE RBK ROUND BLACK SWH SQUARE WHITE SBK SQUARE BLACK		CSL __ CUSTOM SUSPENSION LENGTH 24"-120" ⁸ EM EMERGENCY BATTERY CT CUSTOM THREAD ⁹ 2CP INCLUDE 2" CANOPIES		

1 IMPERIAL DIMENSIONS ARE NOMINAL. ACTUAL DIMENSIONS ARE METRIC.
 2 CUSTOM DIAMETER AVAILABLE BETWEEN 15" - 47" (390-1200MM).
 3 GENERAL AMBIENT ONLY AVAILABLE WITH 750 AND 1500 LUMEN OPTIONS.
 4 POWER CABLE IS 18" LONGER THAN SUSPENSION LENGTH. CONSULT FACTORY FOR LONGER LENGTHS.
 5 REPLACE "___" WITH DESIRED COLOR CODE. SEE PAGE 2 FOR COLOR OPTIONS AND CODES.
 6 5" (127MM) CANOPY PROVIDED FOR FEED. 2" (50.8MM) CANOPIES FOR NON-FEED PROVIDED UPON REQUEST.

7 LEAVE BLANK IF NOT APPLICABLE. STRING TOGETHER MULTIPLE SELECTIONS.
 8 REPLACE "___" WITH LENGTH OF DESIRED SUSPENSION.
 9 CONSULT FACTORY FOR CUSTOM THREAD COLOR OPTIONS.

SEE ADDITIONAL OPTIONS FOR SIZE, TRIM FINISH, AND CUSTOMIZATION AT [SABIN.BUILD](#)



EXAMPLE PART NUMBER: LYR-D-L-35(900)-927-SC-D1500-DSP-10-LHWH-15PM-PCGY-ACSLV-RWH

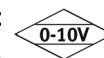

DATE	PROJECT	FIRM	FIXTURE TYPE
------	---------	------	--------------

SWATCHES

Layer utilizes 1.5mm felt and has the option to add trim and customize color for cable, thread, and cord (for lit fixtures.)

Contact the factory for additional color options.

1.5MM FELT

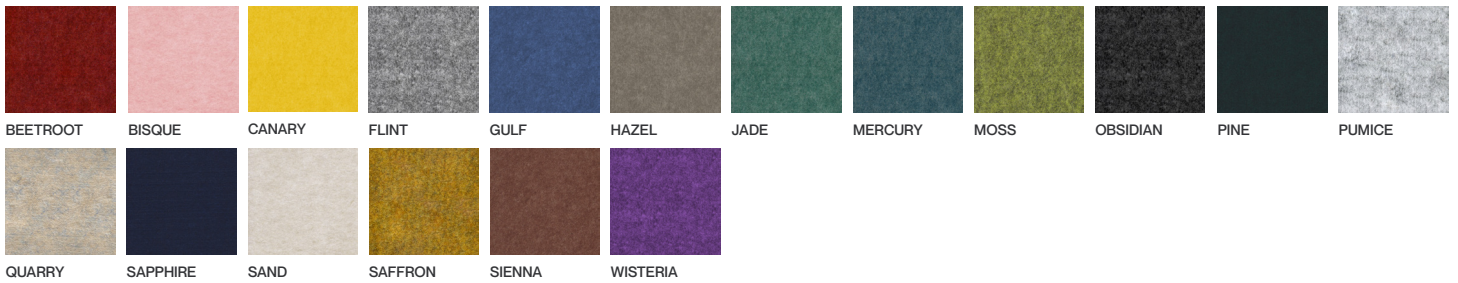

WEBBING

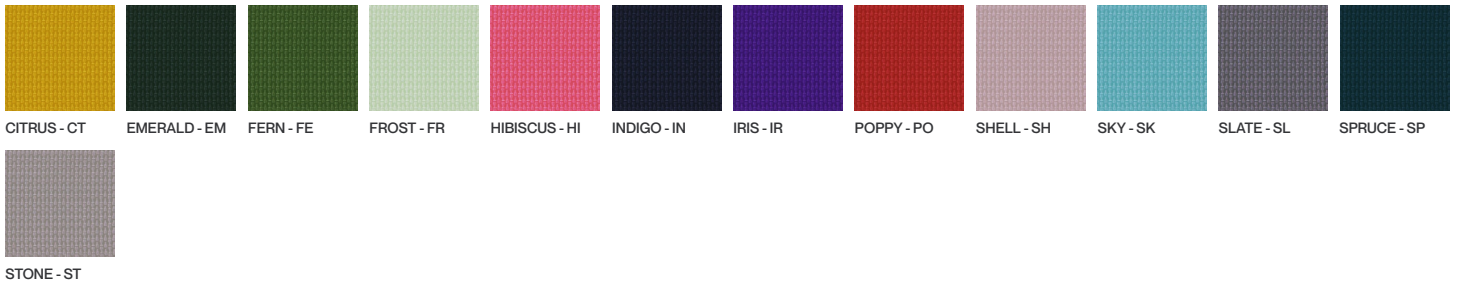

CORD

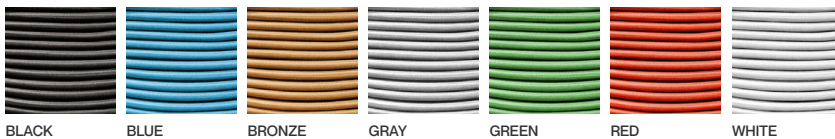

CABLE

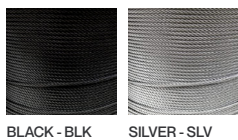

Declare.

PET Acoustic Felt
Sabin LLC

Final Assembly: Chicago, Illinois, USA
Life Expectancy: 20 Years
End of Life Options: Salvageable/Reusable in its Entirety, Recyclable (100%)

Ingredients:
Polyethylene Terephthalate; Benzenamine, 4-(1-methyl-1-phenylethyl)-N-[4-(1-methyl-1-phenylethyl)phenyl]-; Benzenepropanoic acid, 3,5-bis(1-dimethylethyl-4-hydroxy-octadecyl ester); Octadecanamide; N,N'-1,2-ethanediybis-; Stearic Acid; Titanium dioxide

Living Building Challenge Criteria:

I-13 Red List:
 LBC Red List Free % Disclosed: 100% at 100ppm
 LBC Red List Approved VOC Content: Not Applicable
 Declared

I-10 Interior Performance: Not Compliant
I-14 Responsible Sourcing: Not Applicable

SAB-0001
EXP: 01 JUL 2024
Original Issue Date: 2023

INTERNATIONAL LIVING FUTURE INSTITUTE™ living-future.org/declare

Colors are subject to slight variation from your screen or paper to the finished product.

DATE	PROJECT	FIRM	FIXTURE TYPE
------	---------	------	--------------

ACOUSTIC PERFORMANCE DATA

ALL SABIN PRODUCTS ARE SUBJECT TO ACOUSTIC TESTING. PERFORMANCE VALUES WILL VARY BASED ON INSTALLATION FACTORS SUCH AS DENSITY AND MOUNTING HEIGHT.

SABINS A SABIN IS A UNIT OF SOUND ABSORPTION DEFINED AS THE AMOUNT OF SOUND ABSORBED BY ONE SQUARE FOOT OF A PERFECT ABSORBER. IT WAS INITIALLY CONCEIVED AS THE EQUIVALENT OF 1 SQUARE FOOT OF OPEN WINDOW, REFLECTING NO SOUND BACK INTO THE INTERIOR. SABINS ARE USED TO EXPRESS THE TOTAL EFFECTIVE ABSORPTION FOR THE INTERIOR OF A ROOM. THIS CHART INDICATES AVERAGE SABINS PER UNIT AT THE NOTED FREQUENCIES WHICH REPRESENT THE TYPICAL RANGE OF HUMAN SPEECH OF 200-2500 HZ.

NRC NOISE REDUCTION COEFFICIENT (NRC) IS A SINGLE NUMBER VALUE RANGING FROM 0.0 TO 1.0 THAT DESCRIBES THE AVERAGE SOUND ABSORPTION PERFORMANCE OF A MATERIAL. AN NRC OF 0.0 INDICATES THE OBJECT DOES NOT ABSORB MID-FREQUENCY SOUND ENERGY, BUT REFLECTS IT. AN NRC OF 1.0 INDICATES THAT THE SOUND ABSORPTION PERFORMANCE OF THE MATERIAL IS EQUAL TO ITS SURFACE AREA (MEASURED IN UNITS SABIN), OR CONCEPTUALLY 100% SOUND ABSORPTION.

PROJECTED NRC = .95

TOTAL SOUND ABSORPTION WILL VARY BASED ON DESIGNED PRODUCT CONFIGURATION. SABIN TESTS ALL PRODUCTS IN MULTIPLE CONFIGURATIONS. PLEASE CONTACT SABIN OR YOUR LOCAL AGENT FOR MORE INFORMATION.

SABIN LAYER FAMILY

PROJECTED PERFORMANCE

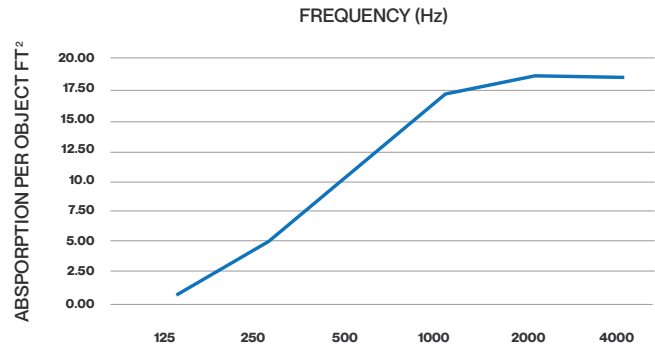

DIMENSIONS + WEIGHT

SERIES	DIAMETER ¹	HEIGHT ^{1,3}
LYR-D-L	12" (300MM) 24" (600MM) 35" (900MM) 47" (1200MM) CD ²	2" (60MM)

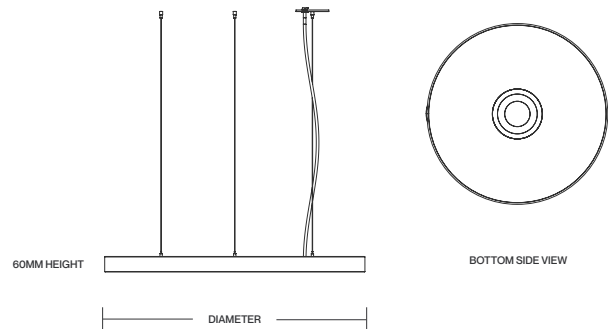

¹ IMPERIAL DIMENSIONS ARE NOMINAL. ACTUAL DIMENSIONS ARE METRIC.

² CUSTOM DIAMETER AVAILABLE BETWEEN 12" - 47" (300-1200MM).

³ GRIPPERS ADD AN ADDITIONAL 0.6" (16MM) TO HEIGHT.

* ALL STANDARD DIMENSIONS ARE ECO-CONSCIOUS, MAXIMIZING MATERIAL USE AND MINIMIZING WASTE. CUSTOM DIMENSIONS RESULT IN EXCESS MATERIAL WASTE.

See Dimensions and Weight Table for Limitations

WEIGHT

PLEASE CONSULT THE FACTORY FOR PRODUCT WEIGHTS BASED ON CONFIGURATION AND PART NUMBERS.

DATE	PROJECT	FIRM	FIXTURE TYPE
------	---------	------	--------------

PHOTOMETRICS

*ACTUAL RESULTS PENDING

NARROW OPTIC

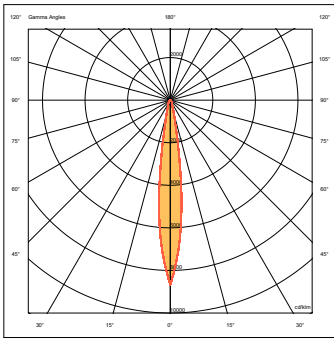

SPOT OPTIC

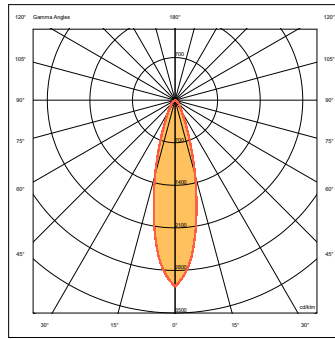

FLOOD OPTIC

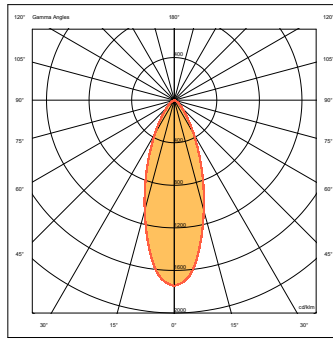

WIDE OPTIC

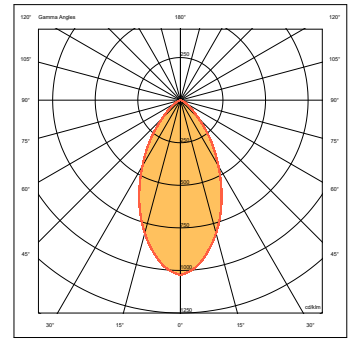

GENERAL AMBIENT OPTIC

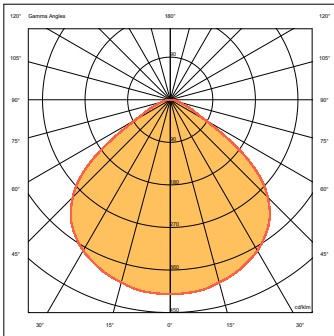

DELIVERED LUMENS

LUMEN PACKAGE	NARROW SPOT	SPOT	FLOOD	GENERAL AMBIENT
LP (750LM)	757	734	723	677
SP (1500LM)	1189	1153	1136	1064
HP (2000LM)	2327	2288	2139	N/A
VH (2500LM)	2909	2860	2854	N/A
VVH (3000LM)	3490	3432	3209	N/A

*DELIVERED LUMENS BASED ON A 3500K CCT.

CCT MULTIPLIER

CCT MULTIPLIER	2700K	3000K	3500K	4000K
	0.9	0.95	1.00	1.01

DATE	PROJECT	FIRM	FIXTURE TYPE
------	---------	------	--------------

ACOUSTIC MATERIAL

OUR 1.5MM AND 9MM PET (POLYESTER) FELT PANELS CONTAIN MINIMUM 60% POST-CONSUMER RECYCLED POLYESTER STAPLE FIBER. THE MATERIAL IS MOISTURE RESISTANT, FIRE RATED AND RECYCLABLE. THE POROUS MATERIAL IS AN OUTSTANDING ABSORBER OF ACOUSTIC ENERGY.

- FIRE RETARDANT: ASTM E84 CLASS A, EN13501 CLASS B
- DECORATIVE: 16 STANDARD COLORS
- CONSTRUCTION: 100% POLYESTER FIBER (PET)

CONSTRUCTION

A HIGHLY ENGINEERED, ROBUST ACOUSTIC LUMINAIRE COMPRISED OF ≥ 60% RECYCLED PET MATERIAL UTILIZING SEWN CONSTRUCTION TO MAXIMIZE STRENGTH, DURABILITY AND SOUND ABSORBENCY.

LED LIGHT ENGINE

LIGHT MODULE INCORPORATES PREMIUM LEDS WITH HEAT SINK TO MAXIMUM LIFETIME. AVAILABLE IN 2700K, 3000K, 3500K OR 4000K CCT WITH >90 CRI. COLOR ACCURACY = 2.2X SDCM @ 3000K ±66K ΔUV +0.0004 STANDARD DEVIATION COLOR MATCHING (SDCM) BASED ON ANSISTANDARD C78.377A INDICATING THE VISIBLE VARIANCE IN CORRELATED COLOR TEMPERATURE, ALSO REFERRED TO AS "MACADAM ELLIPSE".

ESTIMATED USEFUL LIFETIME

$L_{70} = 62,791$ HOURS
LUMINOUS FLUX MAINTENANCE LIFE $L_{70}(9K)$ BASED ON IES TM-28-147 9000-HOUR TEST AT $T_A = 45^{\circ}C$.

OPTICS

INJECTION MOLDED, LOW PROFILE ACRYLIC LENS DESIGNED FOR EFFICIENT AND HOMOGENEOUS LIGHT DISTRIBUTION WITH SUPERIOR COLOR OVER ANGLE PERFORMANCE. PROVIDES BEAM CONTROL DOWN TO 15° AND UP TO $+90^{\circ}$. OPTICS ARE FIELD CHANGEABLE.

BEAM SPREAD: GENERAL AMBIENT ($90^{\circ}+$), NARROW SPOT (15°), SPOT (25°), FLOOD (40°), WIDE FLOOD (60°), LINEAR SPREAD ($40^{\circ} \times 20^{\circ}$), SOFT FOCUS

ELECTRICAL

HIGH QUALITY CLASS P ISOLATED POWER SUPPLY WITH UNIVERSAL (120-277VAC) INPUT VOLTAGE. MEETS UL OPERATION RATING DRY & DAMP (IP40) MAX $185^{\circ}F$ ($85^{\circ}C$) FOR 50,000 HOUR LIFE. LUMINARIES ARE PRE-WIRED WITH FACTORY INSTALLED BRANCH CIRCUIT WIRING.

POWER FACTOR:
- 0.95 @ 120VAC
- 0.90 @ 277VAC

DIMMING

STANDARD 120-277V CONSTANT CURRENT DRIVER INCLUDES 0-10V ANALOG DIMMING TO 1%
OPTIONS FOR LUTRONECOSYSTEM AT 120/277V, TRIAC/ELV DALI, DMX, AND WARM DIM.

MOUNTING

SUSPENDED WITH $1/16"$ (1.6MM) AIRCRAFT CABLES, COLOR MATCHING CABLE AND GRIPPERS, INSTALLED AT FACTORY. AIRCRAFT CABLES AVAILABLE IN PRECUT LENGTHS OF 36" (915MM), 60" (1524MM), OR 120" (3048MM) WITH FABRIC-COVERED POWER CORD AND 5" (125MM) CANOPY.

CERTIFICATES/LISTING

TESTED IN ACCORDANCE WITH NEC, ANSI/NFPA 70 STANDARDS. ETL LISTED IN ACCORDANCE WITH UL STANDARDS. INDOOR USE ONLY. SUITABLE FOR DRY LOCATIONS, IP20, ROHS COMPLIANT. TITLE 24 JA8-2016 FOR 90 CRI CONFIGURATIONS ONLY.

WARRANTY

FIXTURE RATED FOR OPERATION IN CONDITIONED ENVIRONMENTS UP TO $77^{\circ}F$ ($25^{\circ}C$). FIXTURE IS WARRANTIED TO BE FREE FROM DEFECTS AND/OR FAILURE UNDER NORMAL USE AND PROPER STORAGE FOR FIVE (5) YEARS FROM DATE OF SHIPMENT.

CARE

PET ACOUSTICS: REMOVE DUST WITH COMPRESSED AIR, A VACUUM OR LINT ROLLER. ALUMINUM & POLYMER COMPONENTS: REMOVE DUST AND DEBRIS WITH A CLEAN, DRY, OR DAMP LINT-FREE CLOTH.